

Service manual Minimat 64 L

Version: 2.01

Ident:

Series:

Part-Number: X1220

This part can be ordered.

Chapter

baking chamber, Minimat 64 L 400V 50Hz - V:
control unit, Minimat 64 L 400V 50Hz - V:
78019 - door, Minimat 64 L 400V 50Hz - V:
frame, Minimat 64 L 400V 50Hz - V:
installation-room, Minimat 64 L 400V 50Hz - V:

Service manual baking chamber, Minimat 64 L 400V 50Hz

Version:

Ident:

Series:

Part-Number:

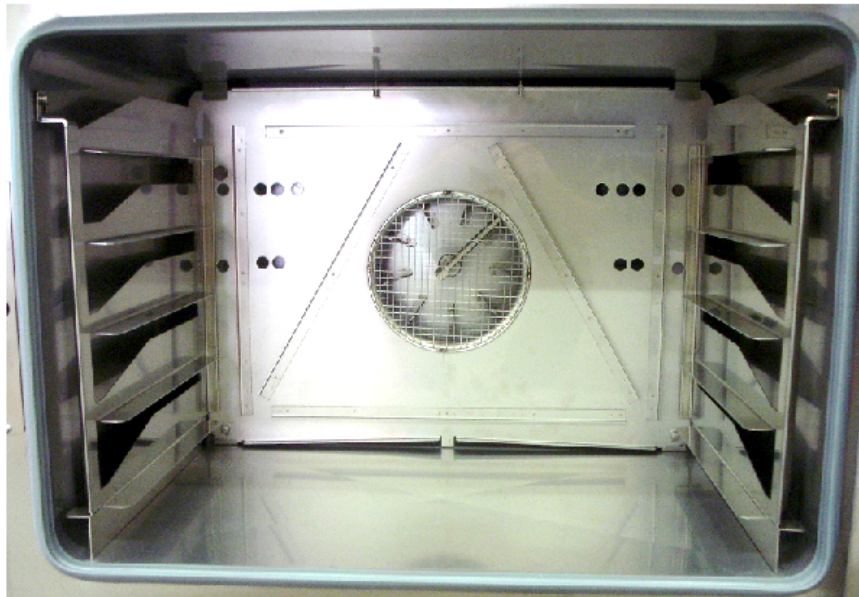

Chapter

X1200-300-005 - heater recirculating, Minimat 64 L 400V 50Hz - V:

X1200-011-000 - oven comfort, Minimat 64 L 400V 50Hz - V:

tray runners - V:

Service manual heater recirculating, Minimat 64 L 400V 50Hz

Version:

Ident:

Series:

Part-Number: X1200-300-005

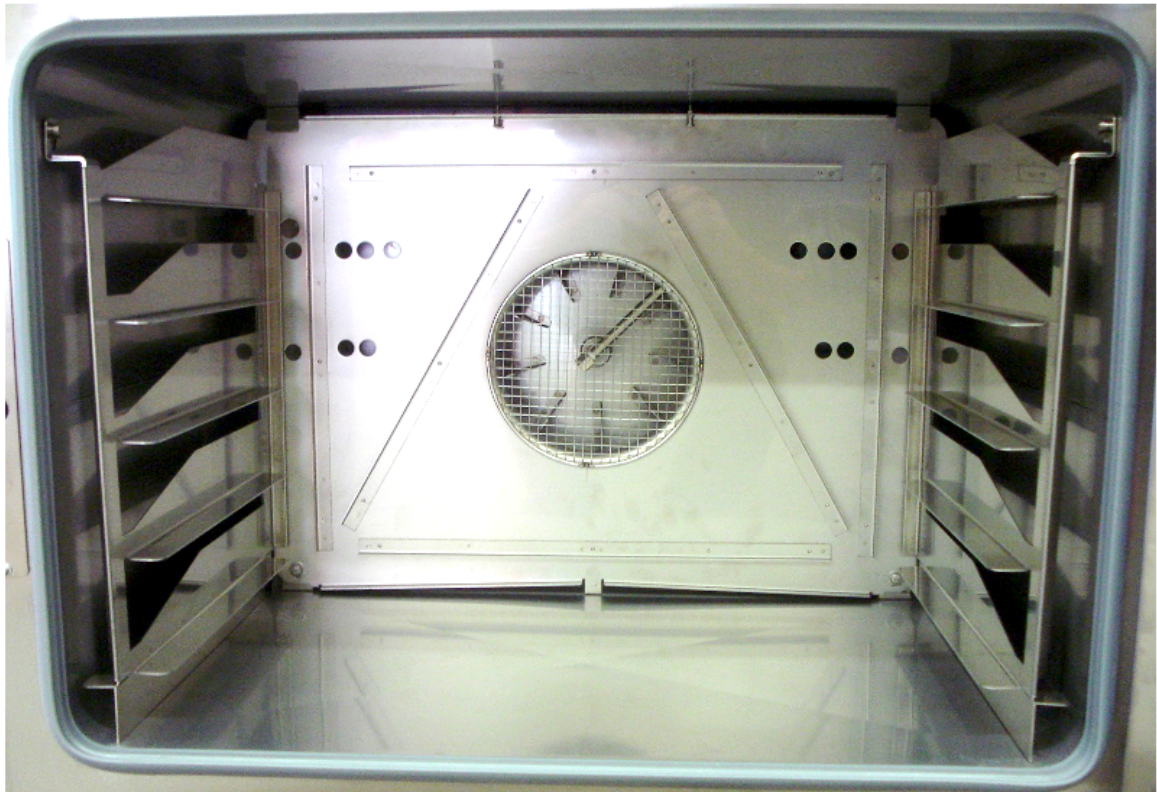

Chapter

00525 - distance sleeve 15 mm
106007 - motor shaft seal
106013 - holder isolation
106025 - support heating 5 kW
107163 - female connector 5-pole
107825 - flange heater 7,5 kW
109859 - multi pin connector 5-pole
110676 - screw M5x12
110753 - washer d= 10,5
111126 - hex nut M6 DIN 934
111127 - hexagonal nut M5
400644 - motor cover
400654 - fan wheel
401520 - steaming pipe
42008 - nut M4 DIN934
42048 - spring ring 5,2
42105 - screw
42210 - washer
42330 - washer
78016 - heater 7500 W
9020-110-005 - fan motor Min64 M, L with 2 rotation speeds
9085-200-003 - seal heater
X1220-900-000 - ventilator cover

Part: distance sleeve 15 mm

Part-Number: 00525

**Part: motor shaft seal**

Part-Number: 106007

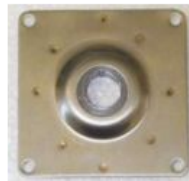
**Part: holder isolation**

Part-Number: 106013

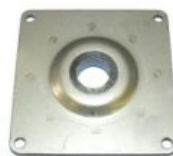
**Part: support heating 5 kW**

Part-Number: 106025

**Part: female connector 5-pole**

Part-Number: 107163

Part: flange heater 7,5 kW

Part-Number: 107825

Part: multi pin connector 5-pole

Part-Number: 109859



Part: screw M5x12

Part-Number: 110676

Part: washer d= 10,5

Part-Number: 110753

Part: hex nut M6 DIN 934

Part-Number: 111126



Part: hexagonal nut M5

Part-Number: 111127

Part: motor cover

Part-Number: 400644

The engine cover must be placed in operation again and secured using the fixing screws.



Part: fan wheel

Part-Number: 400654

The manufacturer tested the fan wheel for imbalance. Keep away any direct heat from the fan wheel for e.g. Blow lamps, otherwise the wheel will not run smoothly. An imbalance of the wheel will damage the motor and yield unsatisfactory baking results. The fan wheel is attached to the motor shaft and a fan wheel removal device must be used when replacing it. At any sign of imbalance the fan wheel must be replaced to prevent further damage.



Part: steaming pipe

Part-Number: 401520

Article No. Wolfen : 401920 The steaming pipe sprays the pre-set amount of water from the operator directly in the middle of the fan wheel. By the turning of the fan wheel the moisture is spread evenly around the baking chamber and enhances shine and volume to the baking product. Steaming is always right after loading the oven. When installing the steaming pipe note the following! 1. Screw the counter nut to the middle of the thread. Otherwise the pipe will be fastened too deeply into the supports. The water flow is minimized or completely blocked. 2. Control the firm placement. Always use tools for installation.



Part: nut M4 DIN934

Part-Number: 42008



Part: spring ring 5,2

Part-Number: 42048



Part: screw

Part-Number: 42105



Part: washer**Part-Number: 42210****Part: washer****Part-Number: 42330****Part: heater 7500 W****Part-Number: 78016**

The ring heater is attached by the securing loops on the welded bolts on the oven wall with the nuts. The heater flange is secured with hexagonal screws. The ring heater can be replaced. When replacing the ring heater the seal must be also be replaced. Work with thread free hexagonal screws to prevent damage that may be caused by heat.

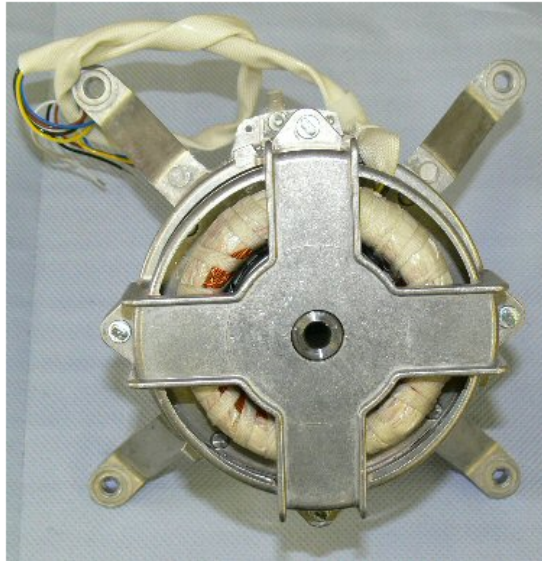
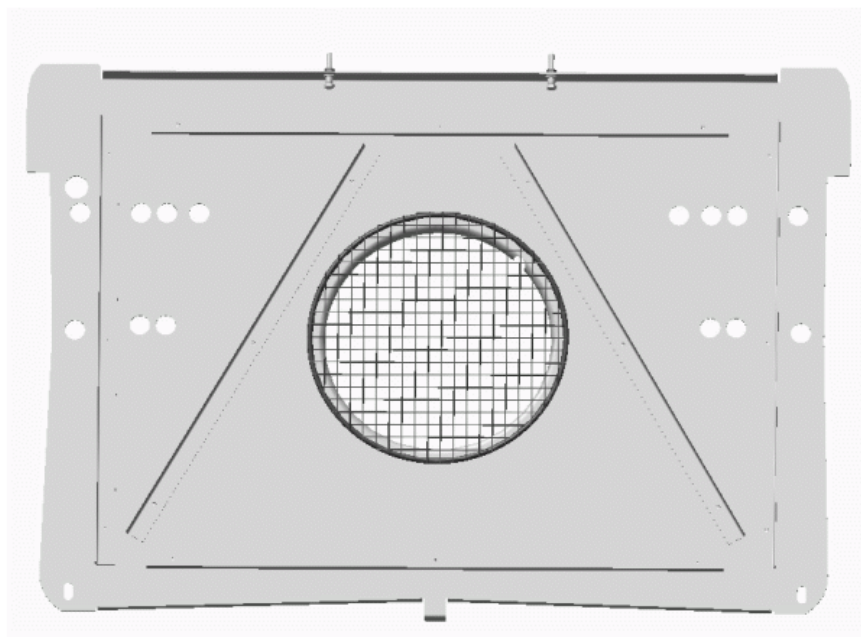

Part: fan motor Min64 M, L with 2 rotation speeds**Part-Number: 9020-110-005****Part: seal heater****Part-Number: 9085-200-003****Part: ventilator cover****Part-Number: X1220-900-000**

Service manual oven comfort, Minimat 64 L 400V 50Hz

Version:

Ident:

Series:

Part-Number: X1200-011-000

Chapter

06035 - tray runners Minimat
08628 - thermostat tube
107663 - punched tray
107923 - thermocouple plug
107924 - thermocouple tube
37981 - capillary tube regulator
38337 - door seal MINIMAT
9030-140-005 - thermocouple

Part: tray runners Minimat**Part-Number: 06035****Part: thermostat tube****Part-Number: 08628****Part: punched tray****Part-Number: 107663****Part: thermocouple plug****Part-Number: 107923****Part: thermocouple tube****Part-Number: 107924**

Part: capillary tube regulator

Part-Number: 37981

The thermostat measures the oven temperature. The fluid in the capillary tube measures the temperature. Be sure not to kink the capillary tube when placing it the result will be a false reading or interruption. Insulate the capillary tube on critical spots (e.g. circuit board) with silicone hose article number 40074.

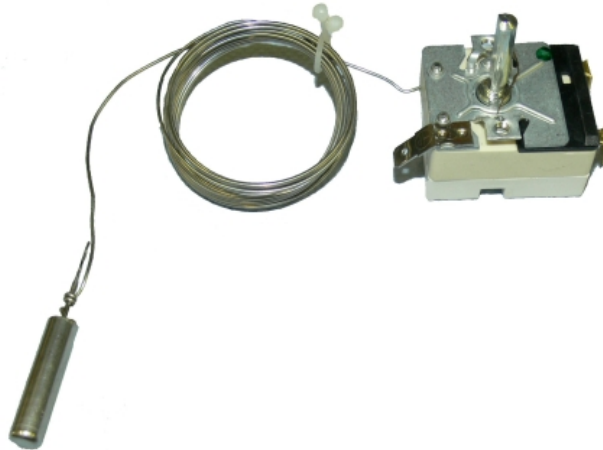

Part: door seal MINIMAT

Part-Number: 38337

The door seal is glued with transparent heat resistant silicone on the radii, on the edges and on the long stretches. Should this be exchanged the old seal must be removed with the help of a knife. Clean the tracks and remove all silicone remains. Ensure when installing that the seal is completely in the frame. Order the door seal as cut ware. Instructions for installation and length of door seal can be found in the assembly instructions.

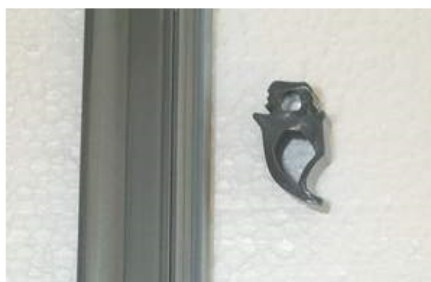

Part: thermocouple

Part-Number: 9030-140-005

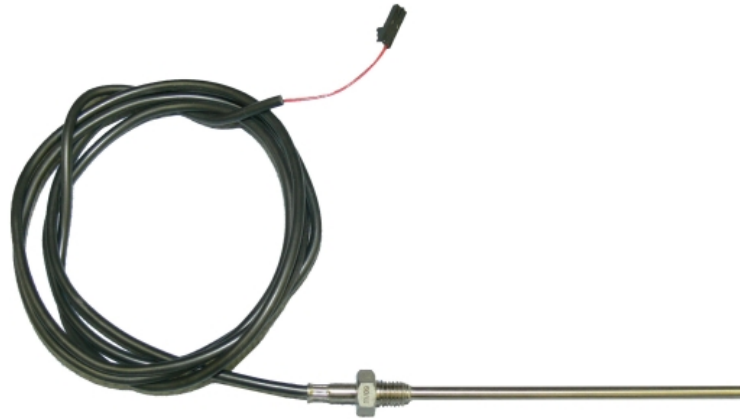

Service manual tray runners

Version:

Ident:

Series:

Part-Number:

Chapter

111502 - tray left 5 plates

111503 - tray right 5 plates

Part: tray left 5 plates

Part-Number: 111502



Part: tray right 5 plates

Part-Number: 111503



Servicemanual control unit, Minimat 64 L 400V 50Hz

Version:

Ident:

Series:

Part-Number:

Chapter

X1200-301-010 - control panel classic assembled, Minimat 64 L 400V 50Hz - V:

X1200-355-000 - control panel comfort assembled, Minimat 64 L 400V 50Hz - V:

X1200-355-026 - slider classic assembled, Minimat 64 L 400V 50Hz - V:

X1200-355-027 - slider comfort assembled, Minimat 64 L 400V 50Hz - V:

Service manual

control panel classic assembled, Minimat 64 L 400V 50Hz

Version:

Ident:

Series:

Part-Number: X1200-301-010

Chapter

107215 - control lamp 120 degrees WB 90
110239 - carrier thermostat
110855 - silicone hose
34862 - knob thermostat
35148 - signal lamp with clip; Attention replaced by 107215
36691 - knob timer
400342 - safety limit switch
400771 - illuminated key attachment adapter
400772 - illuminated key LED 230 V
400773 - illuminated key closing contact
401082 - illuminated key
401083 - illuminated notch (ON / OFF)
421017 - clock timer 60 minutes
70355 - safety limit switch
9030-325-001 - illuminated push-button black
9030-325-002 - button lense flat, "ON" "OFF"
9030-325-003 - button lense flat, steaming
9030-325-004 - button lense flat, fan speed
X1200-355-017 - cover classic tank
X1200-355-018 - cover classic

Part: control lamp 120 degrees WB 90

Part-Number: 107215



Part: carrier thermostat

Part-Number: 110239

Part: silicone hose

Part-Number: 110855



Part: knob thermostat

Part-Number: 34862

Please note when ordering: Thermostat dial and timer dial have different connectors and are not compatible



Part: signal lamp with clip; Attention replaced by 107215

Part-Number: 35148



Part: knob timer

Part-Number: 36691

Please note when ordering: Thermostat dial and timer dial have different connectors and are not compatible



Part: safety limit switch

Part-Number: 400342

The thermostat knob regulates the post running of the fan to prevent the electrical components from overheating.



Part: illuminated key attachment adapter

Part-Number: 400771



Part: illuminated key LED 230 V

Part-Number: 400772

LED only with manual version as well as IS400 version with water tank.



Part: illuminated key closing contact

Part-Number: 400773

By locking the switch the contactor tightens and the normally open contact closes the inductor circuit as long as the power is supplied.



Part: illuminated key

Part-Number: 401082

The illuminated key does not click in. It only functions as long as it is pressed e.g. steaming



Part: illuminated notch (ON / OFF)

Part-Number: 401083

The illuminated key clicks in when in use. To deactivate the key it must be pressed. For example on/off



Part: clock timer 60 minutes

Part-Number: 421017

Part: safety limit switch

Part-Number: 70355

The temperature safety limit switch (STB) is the overheating protection for the baking chamber. It is activated at a temperature of 360°C. The heater connector switches off and the appliance quits working. Once the oven cools down the STB can be manually reset. The measurement occurs from the fluid in the capillary tube. Ensure when placing the capillary tube that it does not kink. The result is false readings or interruption. Insulate the capillary tube on the critical spots (e.g. circuit board) with silicone hose article number 40074.

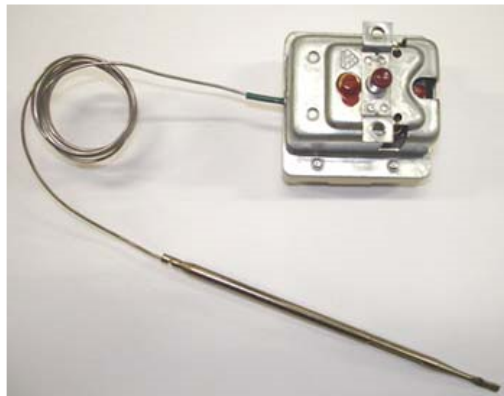

Part: illuminated push-button black

Part-Number: 9030-325-001

**Part: button lense flat, "ON" "OFF"**

Part-Number: 9030-325-002

**Part: button lense flat, steaming**

Part-Number: 9030-325-003

**Part: button lense flat, fan speed**

Part-Number: 9030-325-004



Part: cover classic tank

Part-Number: X1200-355-017

Part: cover classic

Part-Number: X1200-355-018

Servicemanual

control panel comfort assembled, Minimat 64 L 400V 50Hz

Version:

Ident:

Series:

Part-Number: X1200-355-000

Chapter

107695 - blade terminal, double 6,3

110239 - carrier thermostat

110855 - silicone hose

70355 - safety limit switch

9030-320-007 - Comfort Minimat

X1200-355-029 - seal

X1200-355-065 - cover comfort tank, glued

X1200-355-066 - cover comfort, glued

X1200-355-116 - cover control

X1200-355-117 - fastener USB

Part: blade terminal, double 6,3**Part-Number: 107695****Part: carrier thermostat****Part-Number: 110239****Part: silicone hose****Part-Number: 110855**

Part: safety limit switch

Part-Number: 70355

The temperature safety limit switch (STB) is the overheating protection for the baking chamber. It is activated at a temperature of 360°C. The heater connector switches off and the appliance quits working. Once the oven cools down the STB can be manually reset. The measurement occurs from the fluid in the capillary tube. Ensure when placing the capillary tube that it does not kink. The result is false readings or interruption. Insulate the capillary tube on the critical spots (e..g. circuit board) with silicone hose article number 40074.

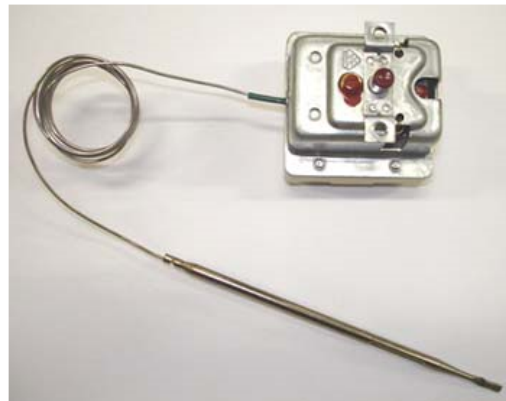

Part: Comfort Minimat

Part-Number: 9030-320-007



Part: seal

Part-Number: X1200-355-029



Part: cover comfort tank, glued

Part-Number: X1200-355-065

Part: cover comfort, glued

Part-Number: X1200-355-066

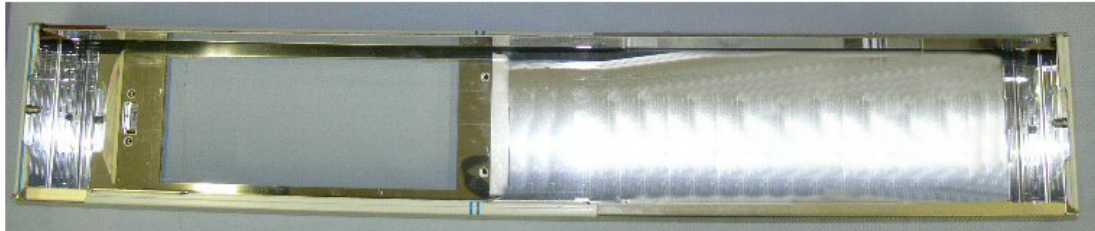
**Part: cover control**

Part-Number: X1200-355-116

Part: fastener USB

Part-Number: X1200-355-117



Service manual

slider classic assembled, Minimat 64 L 400V 50Hz

Version:

Ident:

Series:

Part-Number: X1200-355-026

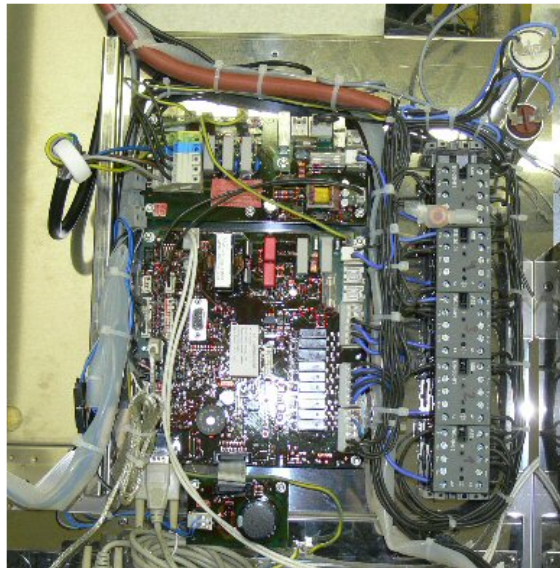

Chapter

- 107082 - fastening element for cable binder 6mm
- 109042 - bearing rail l=225
- 109905 - through terminal, blue 2,5m
- 109906 - PE- terminal
- 111338 - holder for wire harness
- 111343 - cross bridge iso. red 24 A 4/0
- 111344 - continuation clamp gray 2,5qmm
- 111345 - cable with plug for axial fan
- 33884 - relay main switch
- 34100 - transformer
- 36058 - buzzer
- 36304 - cam switch
- 404810 - end clamp grey
- 404814 - intermediate plate clamp
- 9030-430-040 - cable set Minimat classic
- X1200-355-028 - slide Minimat

Part: fastening element for cable binder 6mm

Part-Number: 107082

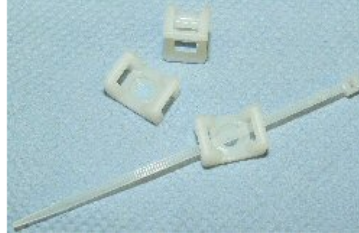
**Part: bearing rail l=225**

Part-Number: 109042

**Part: through terminal, blue 2,5m**

Part-Number: 109905

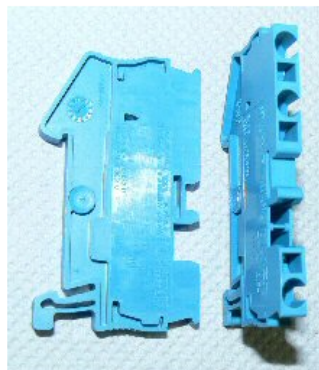
**Part: PE- terminal**

Part-Number: 109906

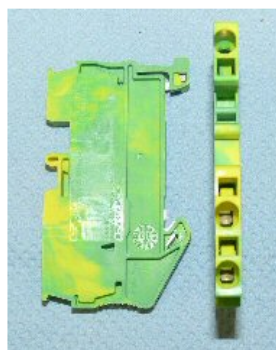

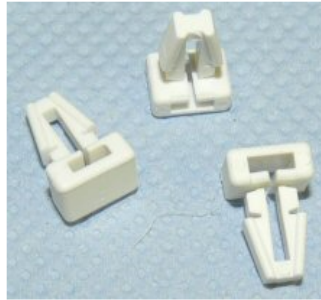
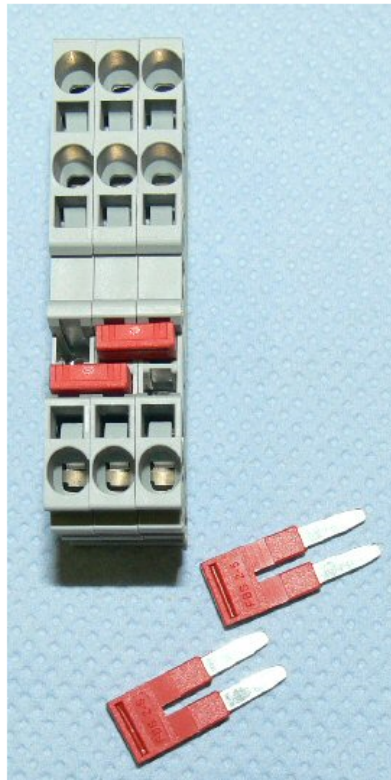
Part: holder for wire harness**Part-Number: 111338****Part: cross bridge iso. red 24 A 4/0****Part-Number: 111343**

Part: continuation clamp gray 2,5qmm**Part-Number: 111344****Part: cable with plug for axial fan****Part-Number: 111345****Part: relay main switch****Part-Number: 33884**

The contactor switches the heater on/off.



Part: transformer

Part-Number: 34100



Part: buzzer

Part-Number: 36058

An acoustic signal is given at the end of the timer. (Buzzer 230 V)



Part: cam switch

Part-Number: 36304

The cam switch is a timed controlled direction changer of the fanwheel and controls the turning contactor.



Part: end clamp grey

Part-Number: 404810



Part: intermediate plate clamp

Part-Number: 404814



Part: cable set Minimat classic

Part-Number: 9030-430-040



Part: slide Minimat

Part-Number: X1200-355-028

Service manual

slider comfort assembled, Minimat 64 L 400V 50Hz

Version:

Ident:

Series:

Part-Number: X1200-355-027

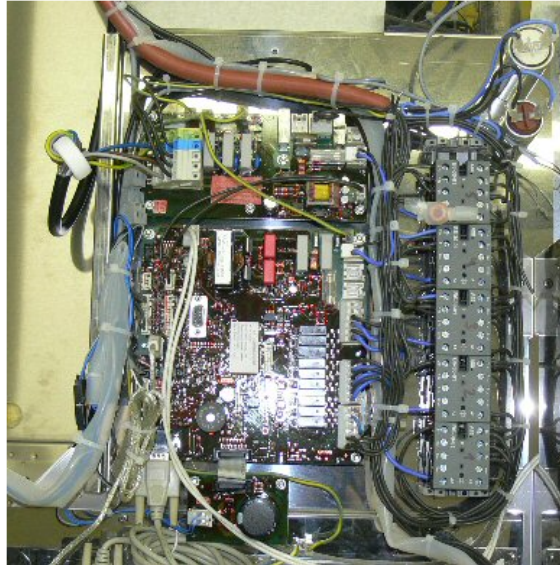

Chapter

- 107082 - fastening element for cable binder 6mm
- 107159 - female multipoint connector 2 pole
- 107161 - female multipoint connector 3 pole
- 107657 - spacer for circuit boards
- 109042 - bearing rail l=225
- 109904 - end clamp grey
- 111231 - spacer
- 111338 - holder for wire harness
- 111345 - cable with plug for axial fan
- 33884 - relay main switch
- 9030-330-001 - motherboard universal
- 9030-330-003 - terminal board active
- 9030-330-004 - additional board hoppo Minimat
- 9030-430-037 - data cable control Comfort-Classic
- 9030-430-041 - cable set Minimat comfort
- 9030-430-113 - USB-extension cord
- 9030-436-003 - capacitor motor 42655 4 μ F
- 9030-436-004 - capacitor motor 42698 1,5 μ F
- X1200-355-028 - slide Minimat

Part: fastening element for cable binder 6mm

Part-Number: 107082

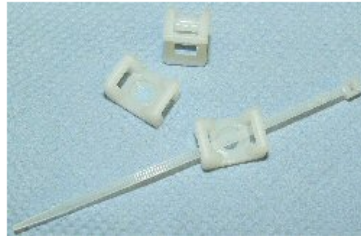
**Part: female multipoint connector 2 pole**

Part-Number: 107159

Part: female multipoint connector 3 pole

Part-Number: 107161

Part: spacer for circuit boards

Part-Number: 107657

**Part: bearing rail I=225**

Part-Number: 109042

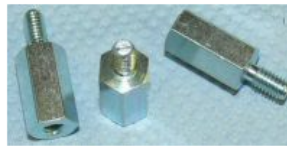
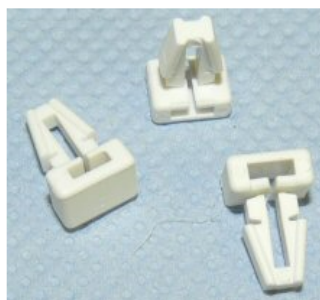

Part: end clamp grey**Part-Number: 109904****Part: spacer****Part-Number: 111231****Part: holder for wire harness****Part-Number: 111338**

Part: cable with plug for axial fan

Part-Number: 111345



Part: relay main switch

Part-Number: 33884

The contactor switches the heater on/off.



Part: motherboard universal

Part-Number: 9030-330-001



Part: terminal board active

Part-Number: 9030-330-003

**Part: additional board hoppo Minimat**

Part-Number: 9030-330-004

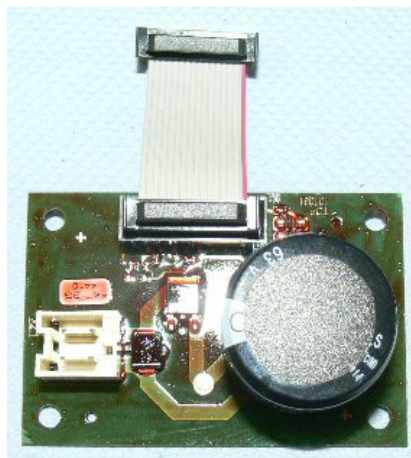
**Part: data cable control Comfort-Classic**

Part-Number: 9030-430-037

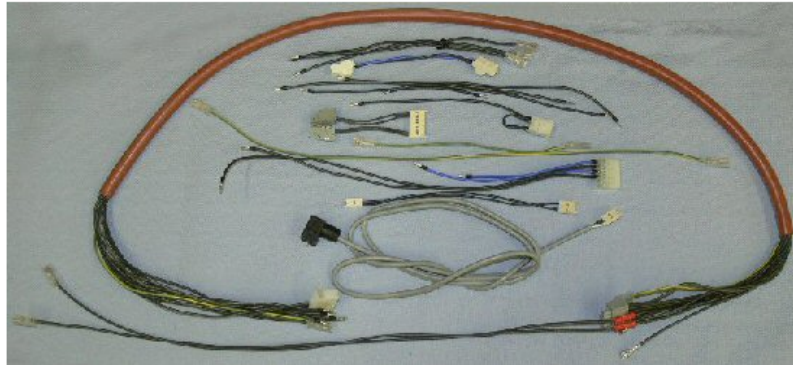

Part: cable set Minimat comfort**Part-Number: 9030-430-041****Part: USB-extension cord****Part-Number: 9030-430-113****Part: capacitor motor 42655 4 μ F****Part-Number: 9030-436-003****Part: capacitor motor 42698 1,5 μ F****Part-Number: 9030-436-004****Part: slide Minimat****Part-Number: X1200-355-028**

Service manual door, Minimat 64 L 400V 50Hz

Version:

Ident:

Series:

Part-Number: 78019

This part can be ordered.

Chapter

X1200-450-001 - door assembled, Minimat 64 M 400 V 50Hz - V:

door latch mechanical, Minimat 64 L 400V 50 Hz - V:

latch electrical left, Minimat 64 L 400V 50 Hz - V:

X1200-400-020 - latch electrical right, Minimat 64 L 400V 50 Hz - V:

Servicemanual

door assembled, Minimat 64 M 400 V 50Hz

Version:

Ident:

Series:

Part-Number: X1200-450-001

Chapter

06288 - hinge bolts top
100171 - silicone underlay Minimat door
107793 - terminal block 6mm² with boring
110608 -
110900 - hose heat shrinkable
111711 - distance peace glass door Minimat
111807 - sealing pane bonded, MIN3, Minimat 64L
31335 - drain gutter MINIMAT2 and MINIMAT3
33427 - halogen lamp 12V 20W
33891 - halogen socket
36050 - DU bushing
37502 - rubber foot silicone
39092 - blind plug, door MINIMAT
42072 - nut
42642 - thrust piece
9000-199-003 - screw thread furrow
9040-110-001 - double ball catch
9040-150-001 - handle Minimat
X1200-400-010 - right door Min 64 L complete
X1200-400-011 - left door Min 64 L complete
X1200-450-028 - left door Min 64 L complete Laib + Seele
X1200-450-029 - right door Min 64 L complete Laib + Seele

Part: hinge bolts top

Part-Number: 06288

In order to correctly set the door, close the door and press with a wrench the door slightly outward. Tighten the upper hexagon with a spanner. The lower door hinge is set in the same way. Align the door bracket and the electric door lock to each other from the center to ensure a smooth running of the door and electric door lock. Check the tightness of the door with the help of a sheet of paper.



Part: silicone underlay Minimat door

Part-Number: 100171

Part: terminal block 6mm² with boring

Part-Number: 107793

Part:

Part-Number: 110608

Part: hose heat shrinkable

Part-Number: 110900

Part: distance peace glass door Minimat

Part-Number: 111711

Part: sealing pane bonded, MIN3, Minimat 64L

Part-Number: 111807

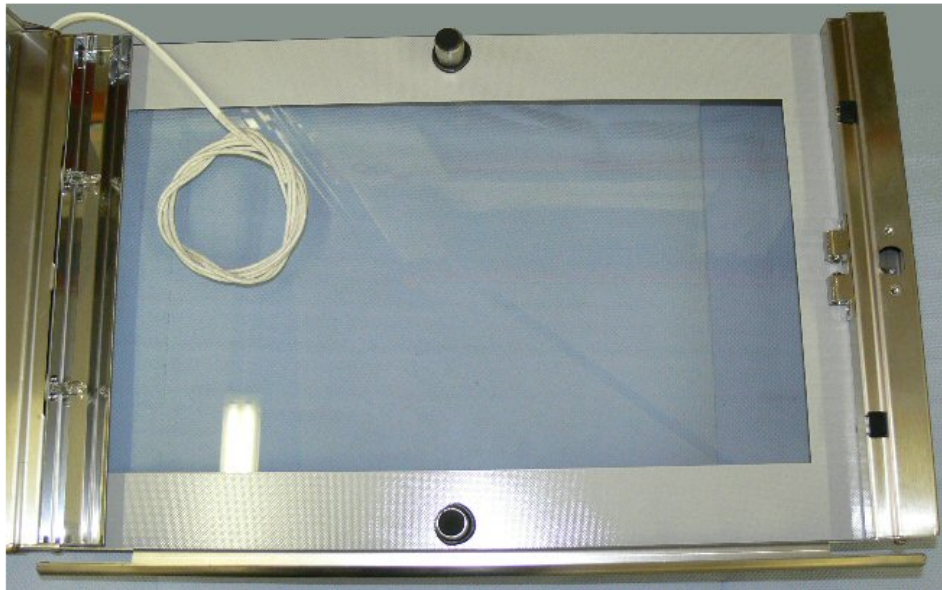

Part: drain gutter MINIMAT2 and MINIMAT3

Part-Number: 31335



Part: halogen lamp 12V 20W

Part-Number: 33427



Part: halogen socket

Part-Number: 33891

Check the porcelain lamp holders and cables for damage. Please do not squeeze or kink the cable.



Part: DU bushing

Part-Number: 36050



Part: rubber foot silicone

Part-Number: 37502

The separator between the sealing pane and the viewing pane ensures that it will not bend. This ensures that even in extreme conditions for example when steaming that the Minimat door remains sealed



Part: blind plug, door MINIMAT**Part-Number: 39092****Part: nut****Part-Number: 42072****Part: thrust piece****Part-Number: 42642****Part: screw thread furrow****Part-Number: 9000-199-003****Part: double ball catch****Part-Number: 9040-110-001**

Part: handle Minimat

Part-Number: 9040-150-001



Part: right door Min 64 L complete

Part-Number: X1200-400-010

Part: left door Min 64 L complete

Part-Number: X1200-400-011

Part: left door Min 64 L complete Laib + Seele

Part-Number: X1200-450-028

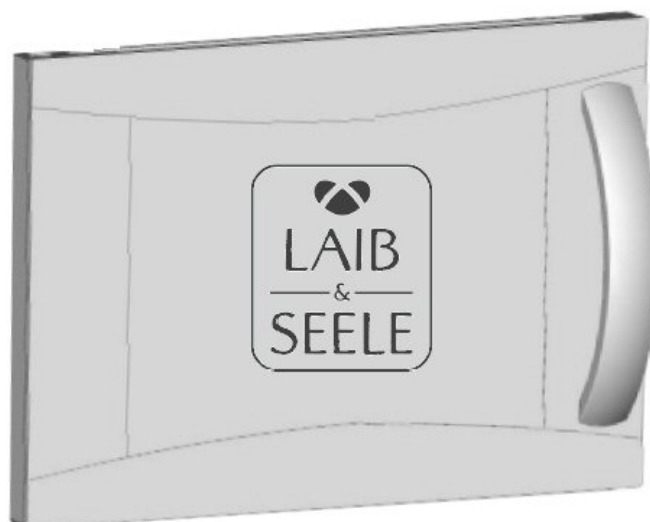

Part: right door Min 64 L complete Laib + Seele

Part-Number: X1200-450-029

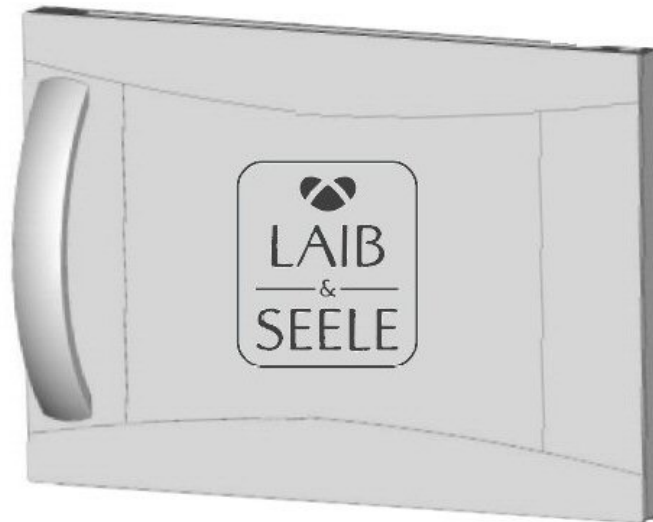

Servicemanual

door latch mechanical, Minimat 64 L 400V 50 Hz

Version:

Ident:

Series:

Part-Number:

Chapter

00000797 - holding plate
106006 - block holder left
107571 - spacers
109123 - safety catch Minimat 64 L
111698 - mechanical door latch right MIN 3
111699 - mechanical door latch left MIN 3
400141 - contact switch door (MAN)
400542 - door latch, mechanical
400600 - mechanical closing sheet, MINIMAT left
400973 - mechanical closing sheet, MINIMAT right

Part: holding plate

Part-Number: 00000797

**Part: block holder left**

Part-Number: 106006

**Part: spacers**

Part-Number: 107571

**Part: safety catch Minimat 64 L**

Part-Number: 109123

Part: mechanical door latch right MIN 3

Part-Number: 111698

Part: mechanical door latch left MIN 3

Part-Number: 111699

Part: contact switch door (MAN)

Part-Number: 400141

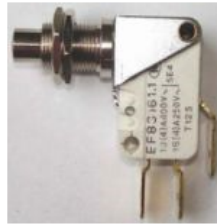

Part: door latch, mechanical

Part-Number: 400542

The door block is fastened with 2 hexagonal screws M5 (wrench size 8) By loosening the screws the door blocks can be optimally adjusted. Tighten the screws once set. Secure the screws with Loctite 243 Article Number 61905.



Part: mechanical closing sheet, MINIMAT left

Part-Number: 400600



Part: mechanical closing sheet, MINIMAT right

Part-Number: 400973



Servicemanual

latch electrical left, Minimat 64 L 400V 50 Hz

Version:

Ident:

Series:

Part-Number:

Chapter

06505 - Door stop
106006 - block holder left
107634 - closing sheet left / door hinge right
107650 - emergency opening door Minimat
109294 - lens flange head screw 4x10
110855 - silicone hose
36195 - electrical magnetic closure (IS)
36198 - door latch, electrical
37722 - ring D10xD18
42004 - screw M4x6
9030-330-004 - additional board hoppo Minimat

Part: Door stop

Part-Number: 06505



Part: block holder left

Part-Number: 106006



Part: closing sheet left / door hinge right

Part-Number: 107634

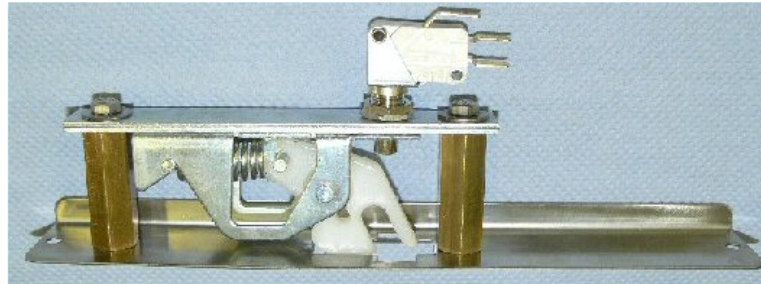

Part: emergency opening door Minimat**Part-Number: 107650****Part: lens flange head screw 4x10****Part-Number: 109294****Part: silicone hose****Part-Number: 110855****Part: electrical magnetic closure (IS)****Part-Number: 36195**

Part: door latch, electrical

Part-Number: 36198

The door block is fastened with 2 hexagonal screws M5 (wrench size 8) By loosening the screws the door blocks can be optimally adjusted. Tighten the screws once set. Secure the screws with Loctite 243 Article Number 61905.



Part: ring D10xD18

Part-Number: 37722

Part: screw M4x6

Part-Number: 42004



Part: additional board hoppo Minimat

Part-Number: 9030-330-004

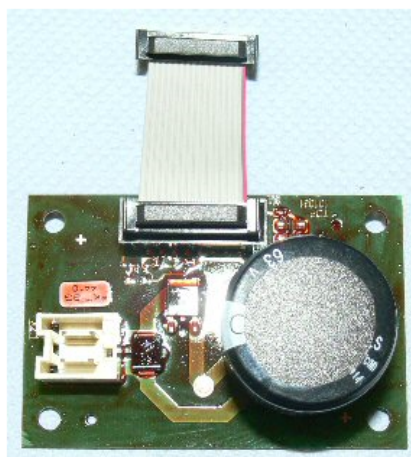

Servicemanual

latch electrical right, Minimat 64 L 400V 50 Hz

Version:

Ident:

Series:

Part-Number: X1200-400-020

Chapter

00000797 - holding plate

106006 - block holder left

107634 - closing sheet left / door hinge right

107635 - closing sheet right / door hinge left

107650 - emergency opening door Minimat

110855 - silicone hose

36195 - electrical magnetic closure (IS)

36198 - door latch, electrical

9030-330-004 - additional board hoppo Minimat

Part: holding plate

Part-Number: 00000797



Part: block holder left

Part-Number: 106006



Part: closing sheet left / door hinge right

Part-Number: 107634

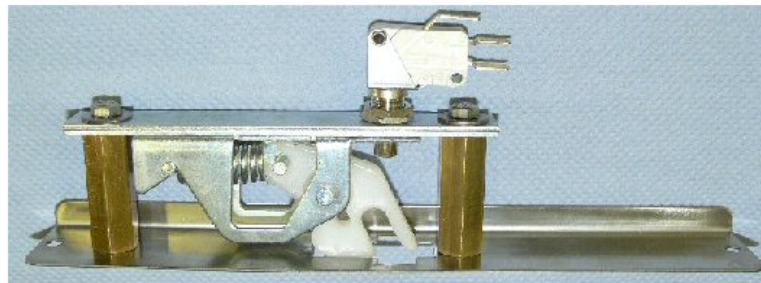

Part: closing sheet right / door hinge left**Part-Number: 107635****Part: emergency opening door Minimat****Part-Number: 107650****Part: silicone hose****Part-Number: 110855**

Part: electrical magnetic closure (IS)

Part-Number: 36195



Part: door latch, electrical

Part-Number: 36198

The door block is fastened with 2 hexagonal screws M5 (wrench size 8) By loosening the screws the door blocks can be optimally adjusted. Tighten the screws once set. Secure the screws with Loctite 243 Article Number 61905.



Part: additional board hoppo Minimat

Part-Number: 9030-330-004

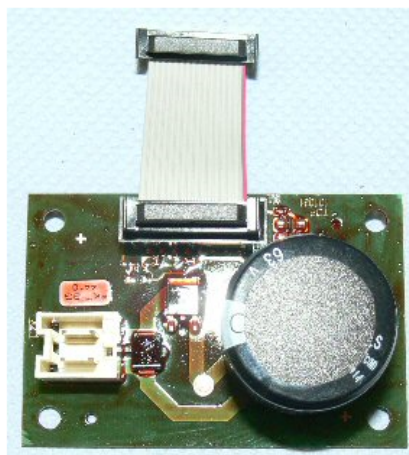

Service manual frame, Minimat 64 L 400V 50Hz

Version:

Ident:

Series:

Part-Number:

Chapter

111586 - frame assembled, Minimat 64 L 400V 50Hz - V:

X1220-500-010 - side frame left

X1220-500-011 - side frame right

Part: side frame left

Part-Number: X1220-500-010

Part: side frame right

Part-Number: X1220-500-011

Servicemanual frame assembled, Minimat 64 L 400V 50Hz

Version:

Ident:

Series:

Part-Number: 111586

Chapter

06286 - hinge pin with grating lower
106162 - rear panel Minimat
106454 - earth sign Ø 12,5
109753 - stiffening plate Minimat
110167 - food welded
111338 - holder for wire harness
33104 - rubber separator
33105 - foot cover cap
33973 - axial fan cover
36219 - cover cap
40003 - silicone seal door
401606 - axial blower
42628 - hexagon screw
78022 - locking pin Minimat
9030-415-003 - cable gland + counter nut
9030-415-004 - angled screw coupling

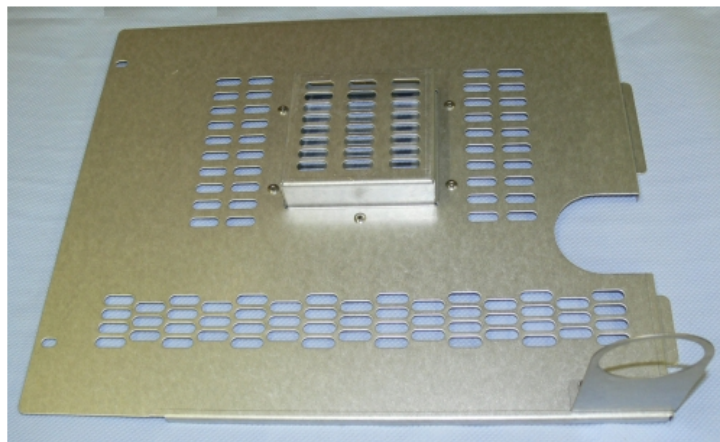
Part: hinge pin with grating lower**Part-Number: 06286****Part: rear panel Minimat****Part-Number: 106162****Part: earth sign Ø 12,5****Part-Number: 106454****Part: stiffening plate Minimat****Part-Number: 109753****Part: food welded****Part-Number: 110167**

Part: holder for wire harness

Part-Number: 111338

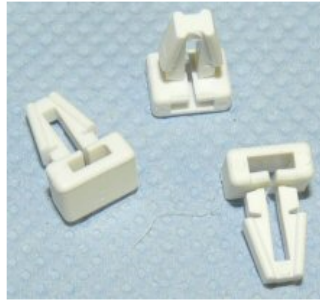

Part: rubber separator

Part-Number: 33104



Part: foot cover cap

Part-Number: 33105



Part: axial fan cover

Part-Number: 33973

To avoid injury the axial fan cover must be installed correctly.



Part: cover cap

Part-Number: 36219

Plug for holes in the side wall. Is used in EUROMAT E2 from May 2013.



Part: silicone seal door

Part-Number: 40003



Part: axial blower

Part-Number: 401606



Part: hexagon screw

Part-Number: 42628



Part: locking pin Minimat

Part-Number: 78022

Part: cable gland + counter nut

Part-Number: 9030-415-003

Part: angled screw coupling

Part-Number: 9030-415-004

Servicemanual installation-room, Minimat 64 L 400V 50Hz

Version:

Ident:

Series:

Part-Number:

Chapter

X1200-200-021 - fixed water connection comfort control, Minimat 64 L 400V 50Hz - V:

111700 - fixed water connection manual control, Minimat 64 L 400V 50Hz - V:

X1200-200-011 - tank connection, Minimat 64 L 400V 50Hz - V:

Servicemanual

fixed water connection comfort control, Minimat 64 L 400V 50Hz

Version:

Ident:

Series:

Part-Number: X1200-200-021

Chapter

107920 - straight male 10/8

111324 - solenoid valve with straight 1 / 4 "thread

33377 - double nipple Ms

403754 - solenoid valve (flow restrictor) Attention replaced by 111324

40485 - teflon hose

9060-115-001 - extansion -inside

9060-510-001 - flow meter

Part: straight male 10/8**Part-Number: 107920****Part: solenoid valve with straight 1 / 4 "thread****Part-Number: 111324**

It is necessary to clean the dirt sieve of the solenoid valve regularly. Particles in the water line will stick to the sieve and interrupt the water flow. Please note the maximum water pressure and other warnings from the data sheets regarding the water connection. The solenoid valve works with a flow pressure of 150 - 600 kPa. You can test the solenoid valve function in the PC - Tool - Test. Attention the test is a continued test and this function is not protected from overload.

Part: double nipple Ms**Part-Number: 33377****Part: solenoid valve (flow restrictor) Attention replaced by 111324****Part-Number: 403754**

It is necessary to clean the dirt sieve of the solenoid valve regularly. Particles in the water line will stick to the sieve and interrupt the water flow. Please note the maximum water pressure and other warnings from the data sheets regarding the water connection. The solenoid valve works with a flow pressure of 150 - 600 kPa. You can test the solenoid valve function in the PC - Tool - Test. Attention the test is a continued test and this function is not protected from overload.



Part: teflon hose**Part-Number: 40485****Part: extension -inside****Part-Number: 9060-115-001****Part: flow meter****Part-Number: 9060-510-001**

Servicemanual

fixed water connection manual control, Minimat 64 L 400V 50Hz

Version:

Ident:

Series:

Part-Number: 111700

Chapter

107066 - access line

109002 - bolting angle 10/8

111324 - solenoid valve with straight 1 / 4 "thread

111502 - tray left 5 plates

111503 - tray right 5 plates

403754 - solenoid valve (flow restrictor) Attention replaced by 111324

40485 - teflon hose

Part: access line**Part-Number: 107066****Part: bolting angle 10/8****Part-Number: 109002****Part: solenoid valve with straight 1 / 4 "thread****Part-Number: 111324**

It is necessary to clean the dirt sieve of the solenoid valve regularly. Particles in the water line will stick to the sieve and interrupt the water flow. Please note the maximum water pressure and other warnings from the data sheets regarding the water connection. The solenoid valve works with a flow pressure of 150 - 600 kPa. You can test the solenoid valve function in the PC - Tool - Test. Attention the test is a continued test and this function is not protected from overload.

Part: tray left 5 plates**Part-Number: 111502**

Part: tray right 5 plates

Part-Number: 111503



Part: solenoid valve (flow restrictor) Attention replaced by 111324

Part-Number: 403754

It is necessary to clean the dirt sieve of the solenoid valve regularly. Particles in the water line will stick to the sieve and interrupt the water flow. Please note the maximum water pressure and other warnings from the data sheets regarding the water connection. The solenoid valve works with a flow pressure of 150 - 600 kPa. You can test the solenoid valve function in the PC - Tool - Test. Attention the test is a continued test and this function is not protected from overload.



Part: teflon hose

Part-Number: 40485



Servicemanual tank connection, Minimat 64 L 400V 50Hz

Version:

Ident:

Series:

Part-Number: X1200-200-011

Chapter

100515 - plug nipple tank
100529 - float switch
106224 - pump holder Minimat manual
107921 - fitting angle 10/8
111490 - holding plate Minimat
112277 - tank lid Minimat
33355 - Bushing
33377 - double nipple Ms
34555 - silicone hose ø9
37882 - level sensor connection
38513 - pump
401268 - tank
40485 - teflon hose
42237 - hose clamp 12-22/9A1
9010-810-003 - magnetic lock
9060-115-001 - extension -inside
9060-510-001 - flow meter
E 100502 - quick connect tank
X1200-355-054 - stiffening plate

Part: plug nipple tank

Part-Number: 100515



Part: float switch

Part-Number: 100529

The level sensor controls the filling level of the tank. A signal is given when the remaining contents are at 10%.



Part: pump holder Minimat manual

Part-Number: 106224

Part: fitting angle 10/8

Part-Number: 107921

Part: holding plate Minimat

Part-Number: 111490

Part: tank lid Minimat

Part-Number: 112277



Part: Bushing

Part-Number: 33355



Part: double nipple Ms

Part-Number: 33377



Part: silicone hose ø9**Part-Number: 34555****Part: level sensor connection****Part-Number: 37882****Part: pump****Part-Number: 38513**

In mobile appliances with a tank the pump for the steamer is 230 V controlled. It puts the required amount of spray pressure in the oven.



Part: tank**Part-Number: 401268****Part: teflon hose****Part-Number: 40485****Part: hose clamp 12-22/9A1****Part-Number: 42237****Part: magnetic lock****Part-Number: 9010-810-003**

Part: extension -inside

Part-Number: 9060-115-001



Part: flow meter

Part-Number: 9060-510-001



Part: quick connect tank

Part-Number: E 100502

In order to avoid a snap in into the quick connector the metal clips have been removed



Part: stiffening plate

Part-Number: X1200-355-054

Urheberrecht:

Das Urheberrecht an diesem Servicehandbuch verbleibt bei der WIESHEU GmbH. Dieses Servicehandbuch ist nur für autorisierte Servicepartner und dessen Personal bestimmt. Sie enthält Vorschriften und Hinweise, die weder vollständig noch teilweise vervielfältigt, verbreitet oder anderweitig mitgeteilt werden dürfen.

Alle Darstellungen, Zeichnungen, Bilder Texte und Angaben sind urheberrechtlich geschützt. Sie unterliegen den gewerblichen Schutzrechten.

Zu diesem Servicehandbuch:

Alle Abbildungen in diesem Dokument sollen die Verständlichkeit unterstützen. Die Abbildungen sind nicht maßstabsgerecht. Teilweise sind dem Originalprodukt ähnelnde Abbildungen dargestellt, die geringfügig abweichen können.

Achtung!

Vermeiden Sie Fehlfunktionen oder Beschädigungen durch falsche Ersatzteile. Wir empfehlen die ausschließliche Verwendung von WIESHEU-Original-Ersatzteilen.

Wiesheu GmbH
Daimlerstrasse 10
DE-71563 Affalterbach
Telefon: +49 (0)7144 / 3 03-0
Fax: +49 (0)7144 / 3 03-11
Service-Telefon: 0800-WIESHEU
E-Mail: info@wiesheu.de
www.wiesheu.de

Stand: 1/13/2014